

CIELO

Litenet presents SKY IP54 from the front of the panel light, which offers a range of recessed mounted light fittings that are designed for commercial hospitality education, age care, health and office lighting applications. The CIELO collection of panel lights are low profiled and are available in satin white finish. This panel light comes with low glare prismatic diffuser as a standard, this range comes with SMD2835 chip with CRI80 upon request CRI90 can be made available.

The CIELO is designed for T-Bat ceiling type or for plasterboard ceiling type.

Non-dimmable ECG standard, Phase Dim/DALI is optional.

50,000 hour life 5 with year warranty L70



CIELO 1195





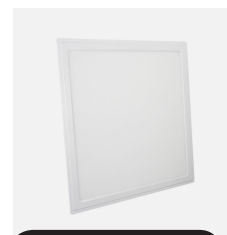

CIELO 595

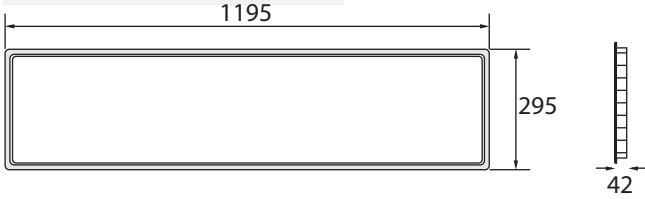
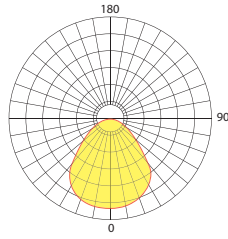

CIELO 295

CIELO 1195





-  SMD LED 3000K / 4000K
-  DC25V -DC42V 500mA - 1000mA
-  10-10V, DALI
-  1195mm x 295mm

Power	20W	30W	40W
LED	SMD	SMD	SMD
Luminous flux 4K	2512lm	4019lm	5024lm
Luminous flux 3K	2184lm	3494lm	4368lm
Dimensions	1195mm x 295mm x 42mm	1195mm x 295mm x 42mm	1195mm x 295mm x 42mm
Mounting	Drop in, Recessed mounted	Drop in, Recessed mounted	Drop in, Recessed mounted
Beam angles	Wide Beam UGR > 19	Wide Beam UGR > 19	Wide Beam UGR > 19
CRI	80	80	80
4000K Part No	CIELO 1195 20804	CIELO 1195 30804	CIELO 1195 40804
3000K Part No	CIELO 1195 20803	CIELO 1195 30803	CIELO 1195 40803

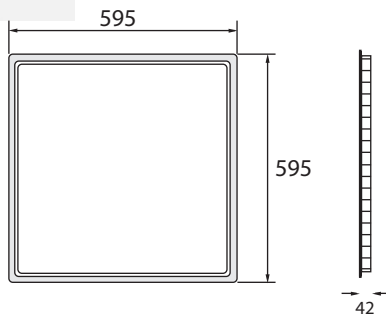
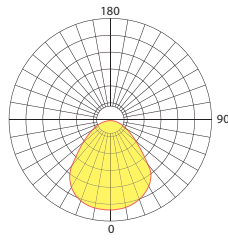
CIELO 595





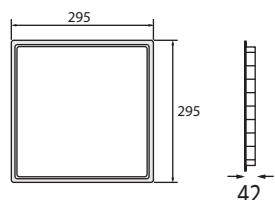
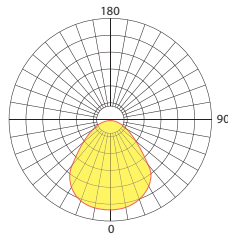

-  SMD LED 3000K / 4000K
-  DC25V -DC42V 500mA - 1000mA
-  10-10V, DALI
-  595mm x 595mm

Power	20W	30W	40W
LED	SMD	SMD	SMD
Luminous flux 4K	2512lm	4019lm	5024lm
Luminous flux 3K	2184lm	3494lm	4368lm
Dimensions	1195mm x 295mm x 42mm	1195mm x 295mm x 42mm	1195mm x 295mm x 42mm
Mounting	Drop in, Recessed mounted	Drop in, Recessed mounted	Drop in, Recessed mounted
Beam angles	Wide Beam UGR > 19	Wide Beam UGR > 19	Wide Beam UGR > 19
CRI	80	80	80
4000K Part No	CIELO 595 20804	CIELO 595 30804	CIELO 595 40804
3000K Part No	CIELO 595 20803	CIELO 595 30803	CIELO 595 40803

CIELO 295



-  SMD LED 3000K / 4000K
-  DC25V -DC42V 350mA - 450mA
-  10-10V, DALI
-  295mm x 295mm

Power	10W
LED	SMD
Luminous flux 4K	2512lm
Luminous flux 3K	2184lm
Dimensions	295mm x 295mm x 42mm
Mounting	Drop in, Recessed mounted
Beam angles	Wide Beam UGR > 19
CRI	80
4000K Part No	CIELO 295 10803
3000K Part No	CIELO 295 10803